

FIS GAS SENSOR SB-AQ1 for AIR QUALITY CONTROLS (VOCs)

The SB-AQ1 is a tin dioxide semiconductor gas sensor which has a very high sensitivity to VOCs, solvents and many other gases. This model is suitable for air quality monitoring for general applications.

Structure

Gas sensitive semiconductor material is a mini bead type and a heater coil and electrode wire are embedded in the element. The sensing element is installed in the metal housing which has 5 holes in the path of gas flow (Fig 1).

Operating conditions

Fig 2 shows the standard operating circuit for this model. The change of the sensor resistance (R_S) is obtained as the change of the output voltage across the fixed or variable resistor (R_L). In order to obtain the best performance and specified characteristics, the values of the heater voltage (V_H), circuit voltage (V_C) and load resistance (R_L) must be within the range of values given in the standard operating conditions shown in the Specification table on the next page.

Sensitivity characteristics

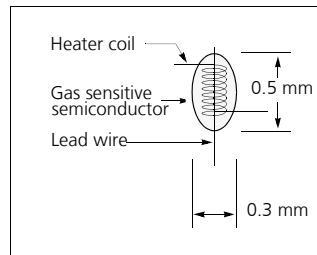

Fig 1a. Sensing element

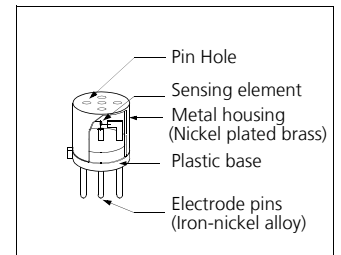

Fig 1b. Configuration

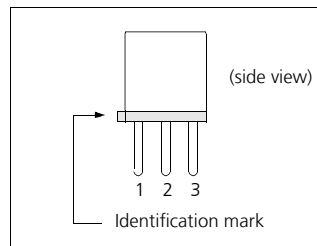

Fig 1c. Pin Layout

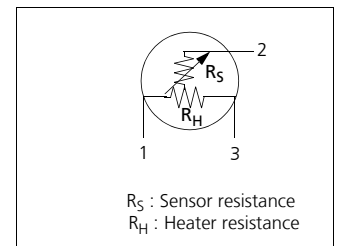

Fig 1d. Equivalent circuit

Fig 3 shows the sensitivity characteristics curves of the SB-AQ1 (typical data). Sensitivity characteristics of the FIS gas sensors are expressed by the relationship between the sensor resistance and gas concentration. The sensor resistance decreases with an increase of gas concentration based on a logarithmic function.

The sensitivity characteristics of the

SB-AQ1 is specified by the following parameters.

- Sensor resistance level: in air
- Sensor resistance change ratio: between hydrogen 10 ppm and in air

See the specification table on the next page for further details.

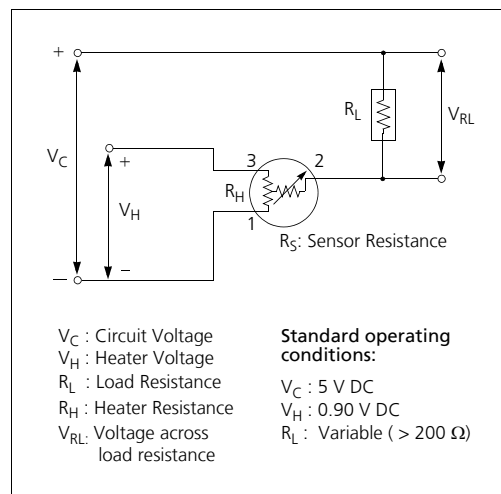

Fig 2. Standard circuit

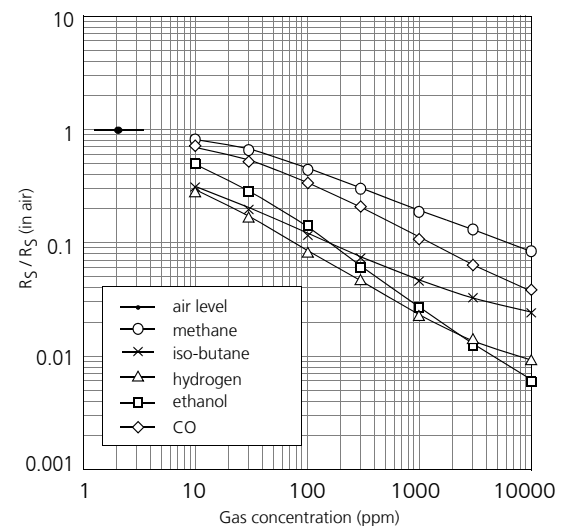

Fig 3. Sensitivity characteristics

Specifications

A. Standard Operating conditions

Symbol	Parameter	Specification	Conditions etc.
V_H	Heater voltage	$0.90V \pm 0.05V$	AC, DC or pulse
V_C	Circuit voltage	Less than 5 V	DC: Pin2 (+) - Pin 1 (-)
R_L	Load resistance	Variable (> 200 Ω)	$P_S < 10$ mW
R_H	Heater resistance	$2.8 \Omega \pm 0.2 \Omega$	at room temperature
I_H	Heater current	130 mA	$I_H = V_H / R_H$ (typical value)
P_H	Heater power consumption	120 mW	$P_H = V_H^2 / R_H$ (typical value)
P_S	Power dissipation of sensing element	Less than 15 mW	$P_S = \frac{(V_C - V_{RL})^2}{R_S}$

B. Environmental conditions

Symbol	Parameter	Specification	Conditions etc.
T_{ao}	Operating temperature	0 °C to 40 °C	Recommended range
T_{as}	Storage temp	-10 °C to 70 °C	
RH	Relative humidity	Less than 95% RH	
(O_2)	Oxygen concentration	21% \pm 1% (Standard condition)	Absolute minimum level: more than 18%
		The sensitivity characteristics are influenced by the variation in oxygen concentration. Please consult FIS for details.	

C. Sensitivity characteristics

Model	SB-AQ1-06		
Symbol	Parameter	Specification	Conditions etc.
R_S	Sensor resistance	1 k Ω to 20 k Ω	in air
β	Sensitivity	0.15 to 0.45	$\frac{R_s \text{ (at } H_2 \text{ 10 ppm)}}{R_s \text{ in air}}$
Standard Test Conditions:		Temp: 20 °C \pm 2 °C Humidity: 65% \pm 5% (in clean air)	V_C : 5.0 V \pm 1% V_H : 0.90 V \pm 1% R_L : 10 k Ω \pm 5%
Pre-heating time: more than 48 hours			

D. Mechanical characteristics

Items	Conditions	Specifications
Vibration	Frequency: 100 cpm	Should satisfy the specifications shown in the sensitivity characteristics after test.
	Vertical amplitude: 4 mm	
	Duration: 1 hour	
Shock	Acceleration: 100 G	
	Number of impacts: 5 times	

Dimensions

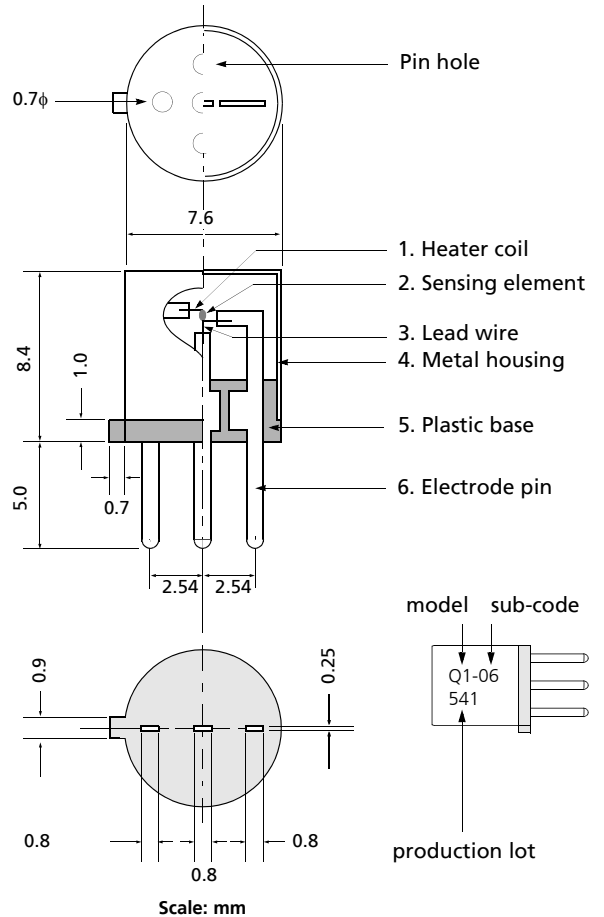

Weight : 0.6g

E. Parts and Materials

No.	Parts	Materials
1	Heater coil	Platinum
2	Sensing element	Tin dioxide (SnO ₂)
3	Lead wire	Platinum
4	Metal housing	Nickel plated brass
5	Plastic base	PBT (Poly butylene terephthalate)
6	Electrode pins	Iron-nickel alloy

Please contact

March 2010

FIS Inc.
3-36-3, Kitazono
Itami, Hyogo
664-0891 Japan
Tel: +81-72-780-1800
Fax: +81-72-785-0073
http://www.fisinc.co.jp